

# NIGHTFORCE

## Reticle Specifications





# Table of Contents

NP-1RR .....	Page 1
Mil-Dot .....	Page 5
NP-R2 .....	Page 7
NP-1 .....	Page 9
NP-2DD .....	Page 10
CH-1 .....	Page 11
CH-2 .....	Page 12
CH-3 .....	Page 13
Reticle applications .....	Page 14
Creating a drop chart .....	Page 15

# NP1-RR

Glass-etched Illuminated Reticle

*This easy-to-use reticle will enhance a shooter's ranging abilities and long range accuracy.*

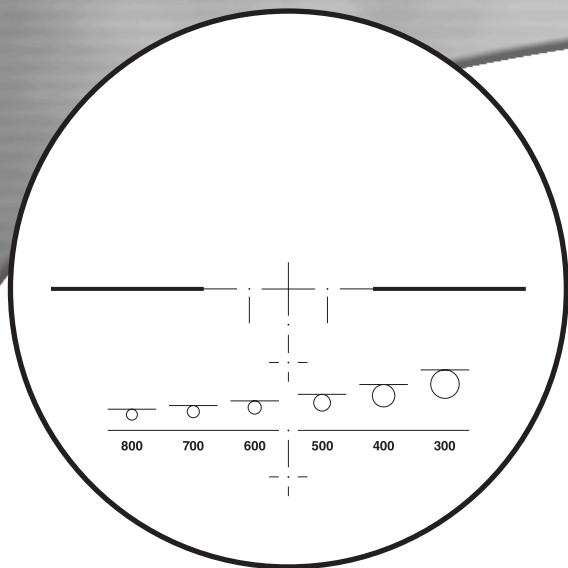

## MAJOR FUNCTIONS

- Easy ranging of the target in the field with no mathematical calculations.
- Quick and accurate compensation for wind drift and bullet drop.

## NP-1RR RANGING SCALE

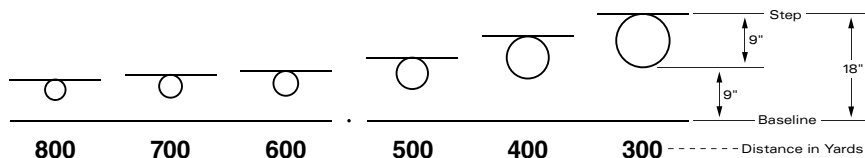

The NP1-RR ranging scale works on the principle of known size of the target in inches. The diagram above is a breakdown of the ranging scale: step, circle, baseline and yards. Distance from step to baseline (inside edges) = 18 inches. Diameter of circle = 9 inches. Distance from bottom of circle to baseline = 9 inches.

## EXAMPLES —

- Deer average 18–20 inches from brisket to shoulder.
- Coyotes average 18–20 inches in height.
- Fox average 10–12 inches in height.
- Prairie dogs average 9–10 inches standing.

The ranging scale remains effective in the field even with small variances in target size.



**SPECIAL NOTE**

The NP1-RR reticle is designed to range 18 inch and 9 inch targets at 15x or 22x, depending on your model of Nightforce scope:

<b>SCOPE MODEL</b>	<b>RANGING POWER</b>
3.5-15x56mm	15x
5.5-22x56mm	22x
8-32x56mm	22x*
12-42x56mm	22x*

\*Signified by an "R" on the power ring.

**ADDITIONAL FEATURES**

You can recalibrate the ranging scale in your Nightforce scope for target sizes other than 18 inches and 9 inches. Decreasing magnification from specified settings will increase values of the ranging scale and bullet drop scale. Increasing magnification will have the opposite effect and will decrease values.

**EXAMPLE — RECALIBRATING THE RANGING SCALE FOR A 20-INCH TARGET**

Place a target 20 inches in height, exactly 300 yards away. Looking through the scope at the target, decrease the magnification until the inside edges of the step and the baseline bracket the target in the 300 yard column. Mark your magnification ring at this point to align with the indicator mark on the tube body. Your scope is now capable of ranging 9 inch, 18 inch and 20 inch targets, depending on the magnification you have the scope set on.

Continued on next page...

**RANGING YOUR TARGET**

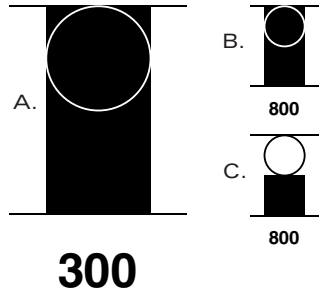

**Example A & B:** A target 18 inches tall, 300 yards away—with scope set at specified magnification—target will fit between the inside edges of the step and baseline in the 300 yard column of the ranging scale. This same target, positioned 800 yards away, will fit in the 800 yard column of the ranging scale. Most deer average 18" from the bottom of the brisket to the top of the shoulder.

**Example C:** Circles are used for ranging targets 9 inches in width. From the bottom of circle to the baseline, this is used for ranging targets 9 inches is height.

# NP1-RR *[continued]*

## DROP CHART

RANGE (YARDS)	CLICKS	ELEVATION (M.O.A.)
300	16	2.0
400	32	4.0
550	64	8.0
700	123	15.4
900	161	20.1

Target turret adjustments with a click value of a 1/8 M.O.A.

## FIELD NOTES

TYPICAL HOLD POINTS FOR MOST  
FLAT SHOOTING CARTRIDGES.

4 M.O.A. = 375–400 yards

8 M.O.A. = 550–600 yards

15 M.O.A. = 700–750 yards

20 M.O.A. = 900–950 yards

## INDICATOR MARKS

THIS SETTING WOULD  
REPRESENT ZERO ON  
THIRD ROTATION →

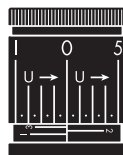

## ESTABLISHING A ZERO AND CREATING A DROP CHART

The bullet drop compensation scale is not calibrated for one specific cartridge. The vertical portion of the reticle is composed of a series of dots placed at specific M.O.A. (minutes of angle) points. Note M.O.A. is based at 100 yards; these M.O.A. hold points will correspond directly with the vertical indicator M.O.A. lines marked on the target turret adjustments.

Zero rifle using the center aim point of the reticle at your desired zero. A 200 yard zero is

recommended. Zero the target turret adjustments with supplied hex wrench and record the rotation setting your zero is on for both windage and elevation. These are the horizontal indicator marks located below the rotating dials. You have now established a zero to which you may return.

With your elevation and windage target turret adjustments zeroed and recorded, set up a target at the first distance you wish to shoot beyond your established zero.

### EXAMPLE —

300 yards, count the number of clicks up to hit the target at 300 yard range from your zero. Record the number of clicks and so on for each range. Then divide all click numbers by eight or four, this converts the click value to M.O.A.. This information is compiled to form a drop chart.

### NOTE —

It is important to count and record the number of clicks required to hit each target from your zero. Now that you have compiled the number of clicks to hit targets at all the various ranges, you can simply convert the number of clicks to M.O.A. by determining the click value of your specific Nightforce riflescope. For 1/8 (.125) M.O.A. click value, divide all click numbers by eight; this converts clicks to M.O.A.. For Nightforce riflescopes with 1/4 (.250) M.O.A. click value divide by four to convert to M.O.A.. This information is compiled to form a drop chart as seen above. This drop chart provides the information needed to hit your target using whole M.O.A. plus clicks.



**EXAMPLE —**

Using target turrets with a click value of 1/8 M.O.A. and your drop chart, you determine the distance requires 8 M.O.A. plus 2 clicks (8.2). Utilizing center aim point at any magnification, turn the elevation target turret 8 M.O.A. plus 2 clicks and shoot. For Nightforce riflescopes equipped with 1/4 M.O.A. click value, turn the elevation target turret adjustment 8 M.O.A. plus 1 click. Note: Dividing clicks by four (.250) or eight (.125) will convert clicks to M.O.A..

**EXAMPLE —**

- (A) 27 clicks divided by four equals 6.75 M.O.A. or 6 M.O.A. + 3 clicks (6.3).
- (B) 27 clicks divided by eight equals 3.375 M.O.A. or 3 M.O.A. + 3 clicks (3.3).

**HOLD POINTS**

To determine bullet drop for a specific cartridge and utilize the reticle hold points, reference your drop chart and set the rifle scope magnification at 22X or 15X, depending on your model of Nightforce rifle scope. Hold at the 8 M.O.A. dot — hold point “C” and add 2 clicks. The usage of the 8 M.O.A. dot represents the course adjustment. Target turrets allow you to fine-tune the 2 clicks. This allows the use of holdover points in conjunction with target turrets for finer adjustment. This will also keep the target turrets within a few clicks of your initial zero and on the same rotation for quick and easy use in the field. The horizontal portion of the reticle has left and right hold point dots representing a 4 M.O.A. hold-off for windage compensation.

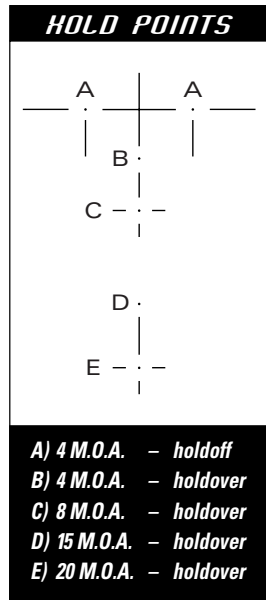

The vertical portion of the reticle has a series of dots placed at specific M.O.A. hold points. These hold points represent 4, 8, 15 and 20 M.O.A. with a 1 M.O.A. spacing around all hold point dots. Example: The first hold point dot below center aim point (hold point “B”) represents 4 M.O.A., the tip of the line above the 4 M.O.A. dot represents a 3 M.O.A. hold point. The tip of the line below the 4 M.O.A. point represents a 5 M.O.A. hold point. This is consistent throughout the remainder of the NP1-RR reticle.

Utilizing this system for relative ranges will enable the shooter to quickly engage the target, while never losing sight of the target or needing to use the target turret adjustments, thus always maintaining your 200 yard zero.

# MIL-DOT

Glass-etched Illuminated Reticle

*This reticle is designed  
for fast range estimation  
and target acquisition  
in tactical situations.*

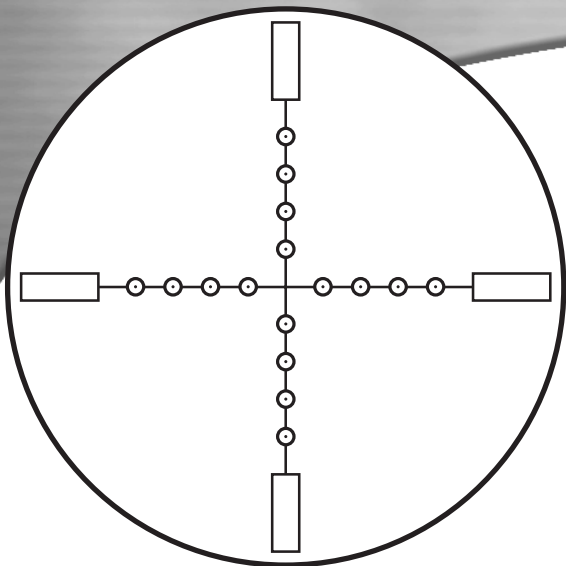

## **TACTICAL SPECIFICATIONS**

Developed by the military, the mil-dot reticle allows the sniper to estimate the range to his target. The mil-dot is now the standard reticle found in law enforcement rifle scopes. The term itself, mil-dot, refers to a trigonometric function called milliradian and a dot, which appears as a series of round shaped reference points located on the reticle.

Advanced developments at Nightforce have resulted in the creation of a new style of mil-dot reticle. Rather than the solid dots that obscure most of the target, the Nightforce mil-dot reticle consists of see-through round dots which are placed on the vertical and horizontal cross lines that serve as reference points. In addition, all four posts are also see-through. Because both the dots and posts are clear, the target is no longer obscured. As a result, these features enable the sniper to more accurately estimate the range to his target.

The dots are spaced precisely 1 mil apart which represents 3.6 inches at 100 yards at specified power. The mil-dot design is etched on precision multi-coated compound glass. This eliminates breakage and misalignment of the reticle. Because of Nightforce's illumination technology, the glass etched reticle glows red and can be illuminated at different intensities. This flexibility ensures excellent reticle contrast in low light when illuminated or a well-defined black reticle when not illuminated.



## TECHNICAL OVERVIEW

To determine the range of an object in yards, one need only determine the numerator and denominator to the following equation:

$$\frac{\text{SIZE OF OBJECT IN YARDS X 1,000}}{\text{SIZE OF OBJECT IN MILS}} = \text{RANGE OF OBJECT IN YARDS}$$

To determine the numerator, calculate the actual height or width of the target measured in yards and multiply that number by one thousand. To determine the denominator, count the number of mil-dots the target's height or width measures in the Nightforce rifle scope.

By way of example, the target is two yards high and the target's height measures two mil-dots. The range of the target is 1,000 yards.

## MIL-DOT RETICLE BULLET DROP AND

$$\frac{2 \times 1,000}{2} = \frac{2,000}{2} = 1,000 \text{ YARDS}$$

## WINDAGE COMPENSATION

The dot spacing can be changed by turning the power ring on the Nightforce rifle scope. This enables the sniper to select from a variety of hold points. For example: Nightforce's 22 power version of the illuminated mil-dot reticle will result in hold points of 5, 10, 15, 20 and 25 minutes of angle when

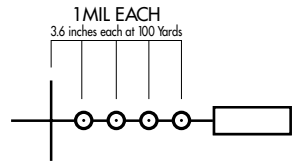

set at 15x. Turning the power ring from 15x to 8x will result in hold points of 10, 20, 30, 40 and 50 M.O.A. The 5.5-22x56 and 8-32x56 models are capable of both sets of hold points. When set at 42x, the Nightforce model 12-42x56 will also result in hold points of approximately 2, 4, 6, 8 and 10 M.O.A. When set at 3.5x—when utilized in the 3.5-15x models—use of the illuminated mil-dot reticle will result in hold points of 10, 20, 30, 40 and 50 M.O.A.

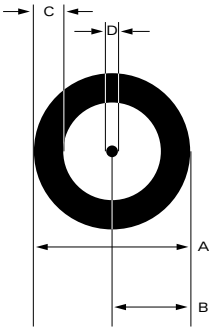

### DOT SPECIFICATIONS

- |                                 |             |
|---------------------------------|-------------|
| A) 1/4 MIL (approx. 3/4 M.O.A.) | C) 1/16 MIL |
| B) 1/8 MIL                      | D) 1/32 MIL |



# NP-R2

## Glass-etched Illuminated Reticle

*Designed for long range shooters, this reticle provides exact hold points for windage and bullet drop as well as multiple zero points.*

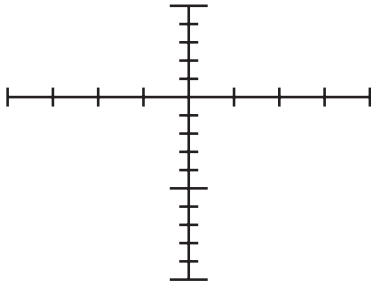

### **TACTICAL SPECIFICATIONS**

The Nightforce NP-R2 is a performance-proven reticle designed specifically to enhance a shooter's long range accuracy and ranging capabilities under a variety of field conditions. Each Nightforce NP-R2 reticle is calibrated at a specified magnification. This enables the shooter to accurately range a target, utilize multiple zero points and select from numerous hold points to compensate for both windage and bullet drop. In addition, the Nightforce NP-R2 reticle is etched on precision multi-coated compound glass. This ensures exact alignment and eliminates breakage. The NP-R2 illuminated ranging reticle is available in all Nightforce rifle scope models:

Due to Nightforce's illumination technology, the glass etched reticle glows red and can be illuminated at different intensities. This technology ensures excellent reticle contrast in low light when illuminated or a well-defined black reticle when not illuminated. In addition, the fine line subtension (area of target covered) makes this reticle ideal for long range applications. Using the latest advancements in laser etching the shooter is guaranteed consistent spacings and therefore accurate range estimation.

What makes the Nightforce NP-R2 reticle truly unique. The vertical line of the NP-R2 reticle is divided into 2 M.O.A. increments (approx. 2 inches at 100 yards). These vertical increments are used for range estimation, multiple zero points and accurate bullet drop compensation. Any size target can be easily ranged using a simple formula: (target size in inches ÷ M.O.A. x 100 = range in yards). Once range is determined select an appropriate hold point based on the bullet drop of your cartridge. The vertical spacings can easily be split into 1 M.O.A. increments further enhancing long range accuracy. The horizontal line is divided into equal 5 M.O.A. increments for windage compensation.

### **RETICLE SPECIFICATIONS**



A. Each vertical increment represents 2 M.O.A.  
(approx. 2 inches at 100 yards).

B. Each indexing vertical increment represents 10 M.O.A.  
(approx. 10 inches at 100 yards).

C. Each horizontal increment represents 5 M.O.A. (approx. 5 inches at 100 yards).

### **TECHNICAL OVERVIEW**

To range an object in yards first determine the target size in inches and divide that number

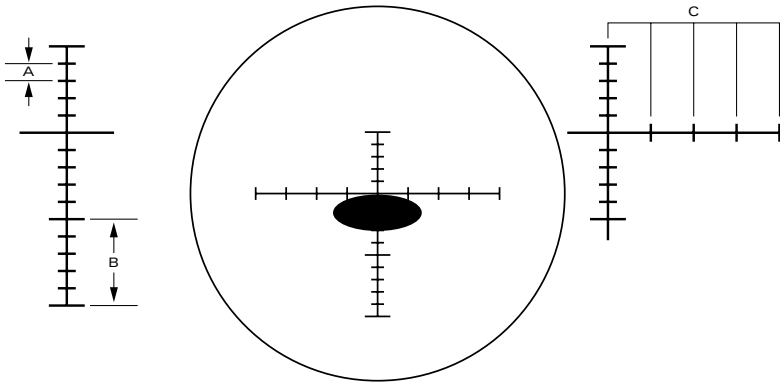

by the amount of M.O.A. measured on the reticle. Multiply this number by 100 (or simply move the decimal point two places to the right). This is the range in yards.

By way of example, the target is 18 inches high and the target's height measures 6 M.O.A.. The range to the target is 300 yards.

$$\frac{\text{SIZE OF OBJECT IN YARDS X 1,000}}{\text{SIZE OF OBJECT IN MILS}} = \text{RANGE OF OBJECT IN YARDS}$$

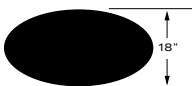

target size  
in inches

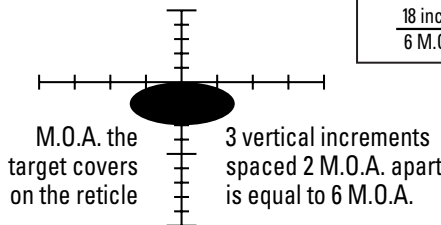

$\frac{18 \text{ inches}}{6 \text{ M.O.A.}} \times 100 = 300 \text{ YARDS}$
---

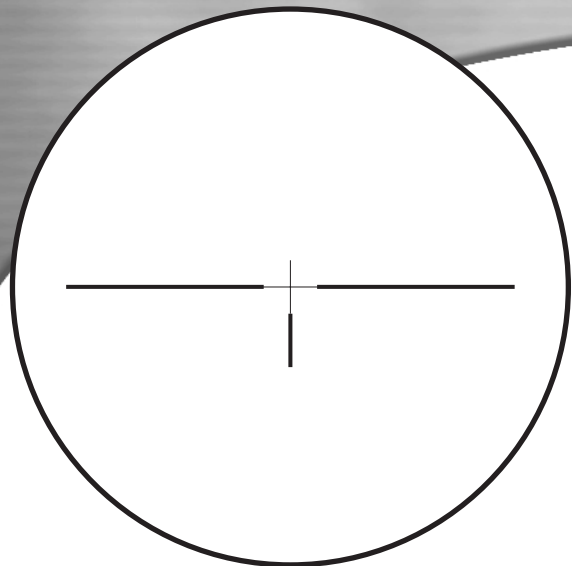

# ***NP-1***

Glass-etched Illuminated Reticle

## **Technical Specifications**

Superior to duplex reticles, this floating three-plex design utilizes all the functional elements of a duplex without unnecessary obstructions of your field of view at the 12 o'clock and 6 o'clock positions. Measured at 22x, a fine crosshair with a .080 M.O.A. subtension extends 4 M.O.A. from center and is bracketed by heavy bars at the 3 o'clock, 6 o'clock and 9 o'clock positions. The NP-1 directs your eye to center for quick target acquisition.

Nightforce owners and members of our own staff pick the NP-1 as their preferred reticle for traditional hunting.

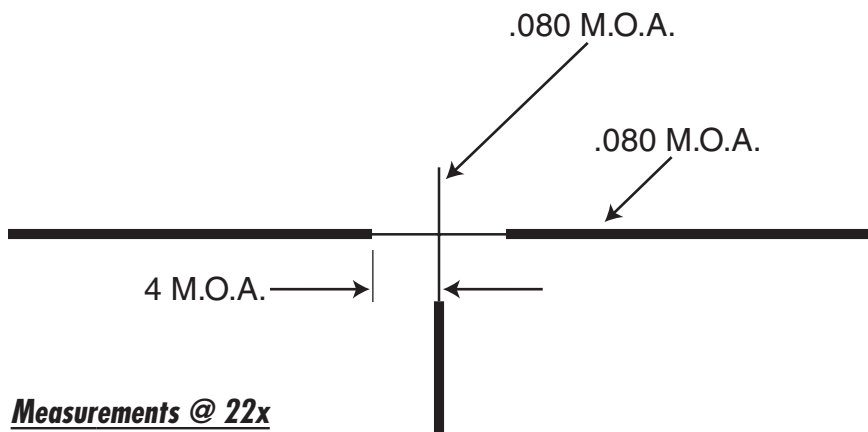

**Measurements @ 22x**

# NP-2DD

Glass-etched Illuminated Reticle

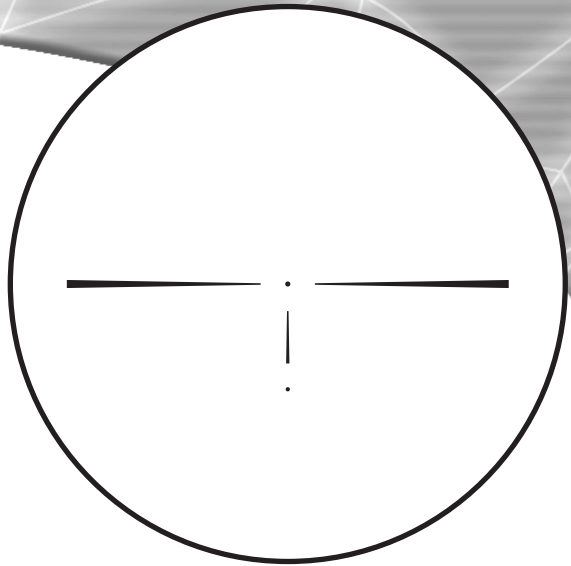

## Technical Specifications

Favored by two classes of shooter, the NP-2DD is the reticle most preferred for predator hunting in low light conditions. When measured at 22x, tapered horizontal bars reaching 4 M.O.A. from the center and a floating .1875 M.O.A. center dot draw the hunter's eye to center for quick target acquisition with minimal illumination flare around the center aimpoint. This reticle is also highly functional for benchrest shooters when combined with Nightforce Precision Benchrest models.

A secondary .125 M.O.A. diameter dot is located 4 M.O.A. below center at 22x. This dot is a 500-600 yard holdover point for most flat shooting cartridges. This simple and effective reticle performs in long range situations while maintaining quick target acquisition capability for short distances.

1,000 yard benchrest competitors prefer the NP-2DD reticle when selecting the 8-32x56 and 12-42x56 models in the Precision Benchrest series for its optimum dot subtension. The unobstructed field-of-view allows the shooter to observe the wind flags to detect a change of condition.

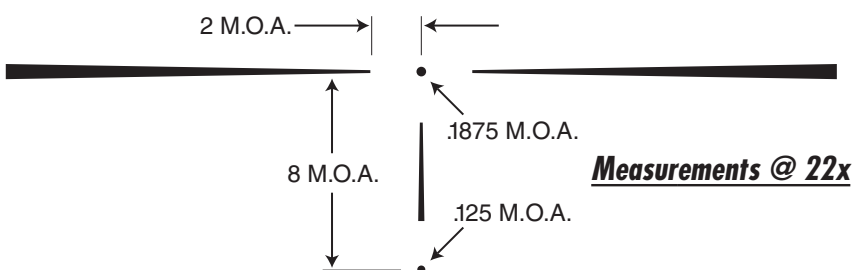

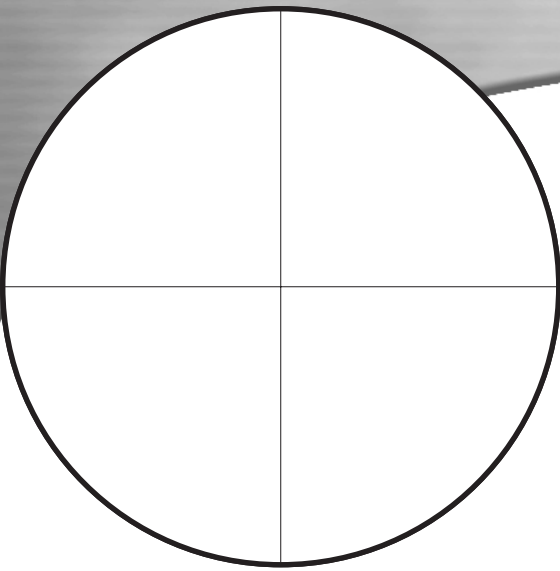

## *CH-1*

Glass-etched Illuminated Reticle

### **Technical Specifications**

Designed for benchrest competition, the CH-1 reticle is a popular choice for a broad range of benchrest shooters. A subtension of .036 M.O.A. measured at 22x was selected after extensive research by Nightforce to offer competitors a reticle with an optimum subtension best suited for benchrest competition.

The CH-1 provides an unobstructed field-of-view, allowing the shooter to observe the wind flags to detect a change of conditions.

.036 M.O.A.

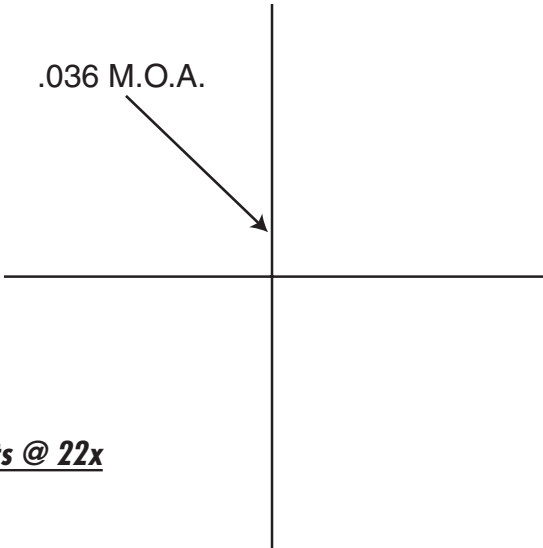

### **Measurements @ 22x**

# CH-2

Glass-etched Illuminated Reticle

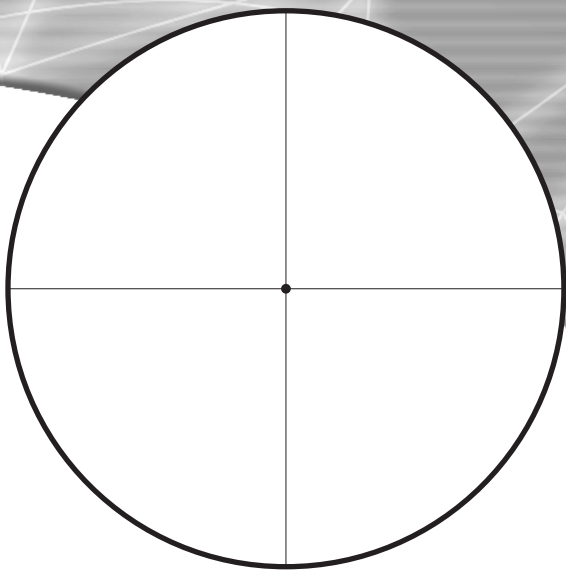

## Technical Specifications

Designed for long range, high power competition, the CH-2 features a .200 M.O.A. dot on a .030 M.O.A. crosshair when measured at 22x. This .200 M.O.A. dot is calibrated for scored shooting on standard NRA high power competition targets.

This reticle was designed in response to extensive research conducted by Nightforce with the cooperation of the world's foremost high power competitors. Nightforce is proud the United States Army Marksmanship Unit has chosen the CH-2 over all reticles for high power competition.

USAMU's use of this reticle in 5.5-22x56 NXS demonstrates Nightforce's achievement in developing the best scope and reticle combination for the elite sport of long range, high power competition.

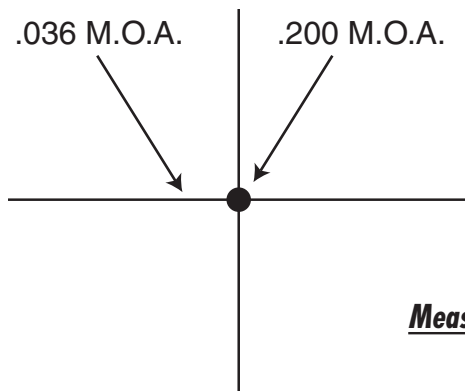

**Measurements @ 22x**



# CH-3

Glass-etched Illuminated Reticle

## Technical Specifications

Designed for benchrest shooting, the CH-3 reticle features an extremely fine crosshair and dot. This fine crosshair and floating dot creates the perfect long range benchrest reticle to compensate for mirage and wind conditions in 1 M.O.A. increments. Combined with a high magnification and variable power, the CH-3 allows the competition shooter to bracket the bullseye while maintaining a center aim point. Unlike Nightforce's other illuminated reticles, only the dot is illuminated on the CH-2 reticle.

This reticle is available in the following NXS models: 5.5-22x56, 8-32x56 and 12-42x56.

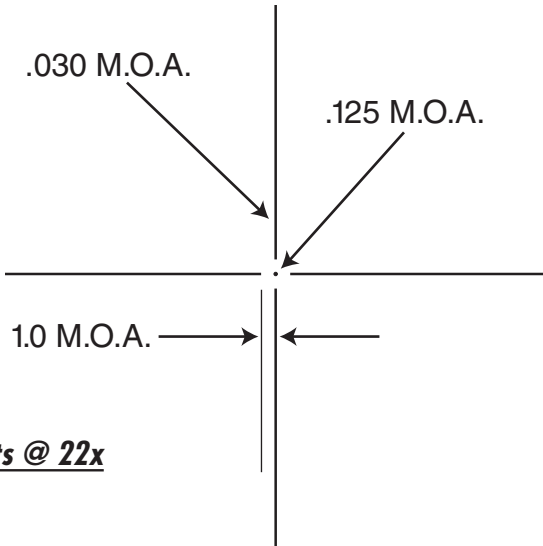

**Measurements @ 22x**

# *Reticle Applications*

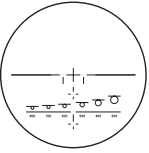
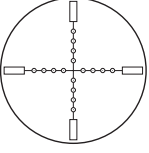
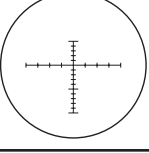
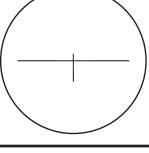
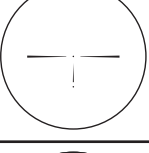
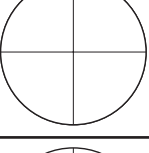
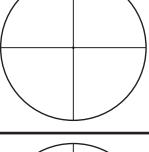
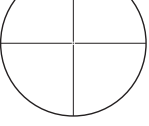
<i>Model:</i>	<i>Availability:</i>	<i>Application:</i>
<b><i>NP-1RR</i></b> 	All NXS All Precision Benchrest	Varmint Hunting Long Range Field Shooting
<b><i>MIL-DOT</i></b> 	All NXS All Precision Benchrest	Tactical Long Range Field Shooting
<b><i>NP-R2</i></b> 	All NXS All Precision Benchrest	Tactical Varmint Hunting Long Range Field Shooting Benchrest
<b><i>NP-1</i></b> 	All NXS All Precision Benchrest	Varmint Hunting Big Game Hunting Tactical
<b><i>NP-2DD</i></b> 	All NXS All Precision Benchrest	Varmint/Big Game Hunting Benchrest - 1,000 yard Low Light Hunting Tactical
<b><i>CH-1</i></b> 	5.5-22x56 NXS 8-32x56 NXS 12-42x56 NXS	Benchrest Competition Varmint Hunting
<b><i>CH-2</i></b> 	5.5-22x56 NXS 8-32x56 NXS 12-42x56 NXS	High Power Competition
<b><i>CH-3</i></b> 	5.5-22x56 NXS 8-32x56 NXS 12-42x56 NXS	Benchrest Competition



# Creating a Drop Chart

With your elevation and windage target turret adjustments zeroed and recorded, set up a target at the first distance you wish to shoot beyond your established zero. From your zero, count the number of clicks up to hit the target. Record the number of clicks and so on for each range. Now that you have compiled the number of clicks to hit the targets at all the various ranges, you can simply convert the number of clicks to M.O.A. by determining the click value of your specific Nightforce riflescope. For 1/8 (.125) M.O.A. click value, divide all click numbers by 8; this converts clicks to M.O.A. + clicks. For Nightforce riflescopes with 1/4 (.250) M.O.A. click value divide by 4 to convert to M.O.A. This information is compiled to form a drop chart (see top of following page). This drop chart provides you with the information needed to hit your target using M.O.A. plus clicks. **Example:** Utilizing the target turret adjustments with a click value of 1/8 M.O.A. and your drop chart, you can determine the distance requires 8 M.O.A. plus 2 clicks (8.2). Utilizing center aiming point at any power magnification, turn the elevation target turret 8 M.O.A. + 2 clicks and shoot. For Nightforce riflescopes equipped with 1/4 M.O.A. click value, turn the elevation target turret adjustment 8 M.O.A. + 1 click from your zero.

NF Target turret adj. 1/8 (.125) M.O.A. click value

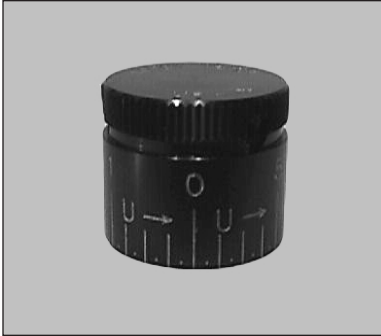

NXS turret adj. 1/4 (.250) M.O.A. click value

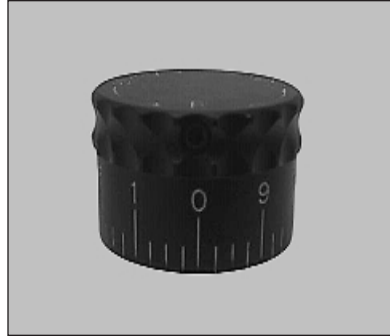

## 1/8 M.O.A. Drop Chart

Yards	Clicks	Elevation M.O.A.+clicks
200	0	0
300	16	2.0
400	32	4.0
500	53	6.6
600	66	8.2

## 1/4 M.O.A. Drop Chart

Yards	Clicks	Elevation M.O.A.+clicks
200	0	0
300	8	2.0
400	16	4.0
500	27	6.3
600	33	8.1

**Note:** Divide clicks by 4 (.250) for 1/4 M.O.A. click value or 8 (.125) for 1/8 M.O.A. click value.

**Example:** (A) 27 clicks divided by 4 equals 6.75 M.O.A. ( $27 \div 4 = 6.75$  M.O.A.) or 6 M.O.A. + 3 clicks(6.3)

(B) 27 clicks divided by 8 equals 3.375 M.O.A. ( $27 \div 8 = 3.375$  M.O.A.) or 3 M.O.A. + 3 clicks(3.3)



**LIGHTFORCE USA**

P.O. BOX 9 • OROFINO, IDAHO, 83544  
(208) 476-9814 • [WWW.NIGHTFORCEOPTICS.COM](http://WWW.NIGHTFORCEOPTICS.COM)

